

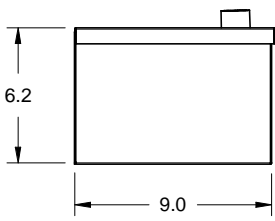

REVISIONS				
ZONE	REV	DESCRIPTION	DATE	APPROVED

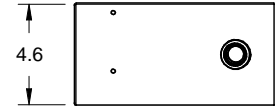

MVK-EIHC with 210 series 414 BTUH Valve.
 Maintain 2" clearance around valve enclosure.
 Supply with 1" gas line minimum.
 System Capacity Not To Exceed 300,000 BTUH.

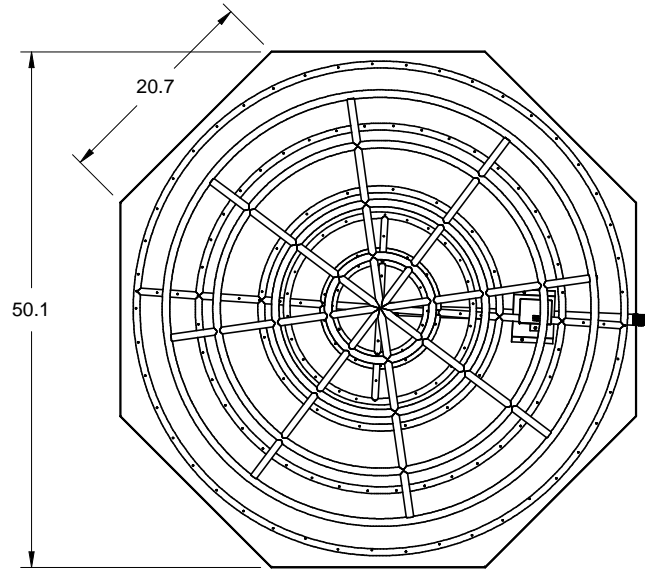
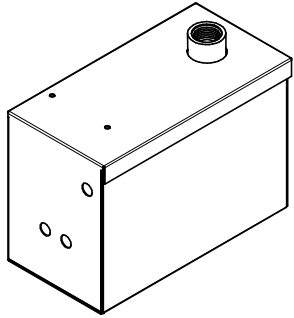
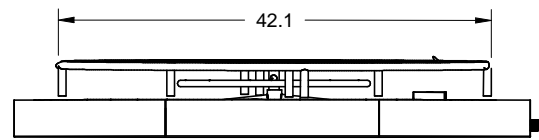
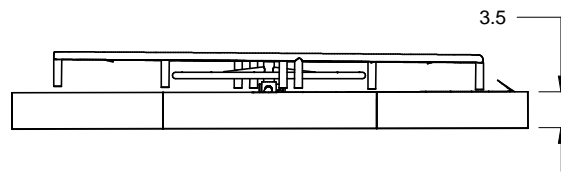

Pan 16 ga 304 stainless steel Stainless Burner Rings Dimensions are Ref Only	DRAWN	DATE	 Hearth Products Controls Co		
	T Hapner	09/04/08			
	CHECKED				
	QA				
	MFG				
APPROVED		SIZE	FSCM NO.	DWG NO.	REV
		A		Prelim Revised	
		SCALE			SHEET

